



This manual is for reference and historical purposes, all rights reserved.

This page is copyright© by M. Butkus, NJ.

This page may not be sold or distributed without the expressed permission of the producer

I have no connection with any camera company

On-line camera manual library

This is the full text and images from the manual. This may take 3 full minutes for the PDF file to download.

If you find this manual useful, how about a donation of \$3 to: M. Butkus, 29 Lake Ave., High Bridge, NJ 08829-1701 and send your e-mail address so I can thank you. Most other places would charge you \$7.50 for a electronic copy or \$18.00 for a hard to read Xerox copy.

This will allow me to continue to buy new manuals and pay their shipping costs.

It'll make you feel better, won't it?

**If you use Pay Pal or wish to use your credit card,
click on the secure site on my main page.**



KODAK
Retina IIc
CAMERA

KODAK RETINA IIc CAMERA

• You have purchased a truly fine camera. Utmost precision is combined with unsurpassed performance; the Retina tradition of quality and versatility is carried to new photographic heights.

The Retina IIc Camera features — auxiliary interchangeable lenses — a coupled rangefinder combined with luminous “view-frame” finder — the Synchro-Compur shutter with light value settings — full flash synchronization — and a built-in self-timer — plus many other refinements that set a new standard for photography.

Before an important picture assignment, a trip, or any special event, shoot a roll or two of film and make a few flash pictures. This will give you practice and provide a check on your equipment.

For those who have used a miniature camera before, the basic steps on the next 5 pages will help you to quickly use your camera. Detailed instructions start on page 6.

T. M. REG. U. S. PAT. OFF.

www.orphancameras.com



COUPLED RANGEFINDER
AND VIEW-FRAME FINDER

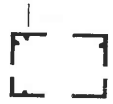

SYNCHRO-COMPUR SHUTTER

INTERCHANGEABLE LENSES



Film

Kodak 135, 20- or 36-exposure magazines; see page 8.



Load

... in subdued light only.



Open the back of the camera by uncovering and pressing the button.

Pull the rewind knob all the way out.

Insert the end of the film in the take-up spool slot; turn the spool by either flange until the perforations on both sides of the film engage the sprocket teeth.



Place the film magazine in the supply chamber, turn and push in the rewind knob. Close the back of the camera.

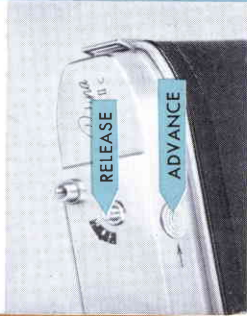

Hold down the **FILM RELEASE BUTTON** and slide the **COUNTER ADVANCE** arrow repeatedly in the direction of the arrow to bring the diamond-shaped mark on the counter dial near 20 opposite the notch for 20-exposure magazines and near 36 for 36-exposure magazines.



Press the film release button; then release it. Swing out the **RAPID WIND LEVER**. Now, do this two more times to bring the counter to 20 or 36, depending on the number of exposures in the magazine.

Settings unloading

A B C

Settings



Open the front of the camera by pressing the **OPENING BUTTON** toward the word **KODAK**, at the same time opening the front cover until it locks in position.

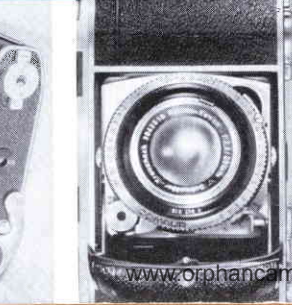

A Determine Exposure — from the light value table on page 21 or from a light meter which gives light value readings.



B Set Exposure — Set the shutter speed by turning the **SHUTTER SPEED RING**. Set the **LIGHT VALUE LEVER** (which also controls the lens openings) to the light value determined as in A above.

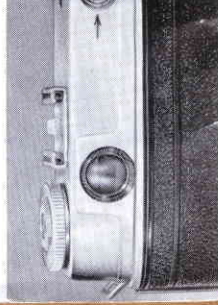

C Focus — Look through the eyepiece; you will see the subject outlined by the view-frame. Move the focusing knob until the outlines of the double image in the diamond-shaped rangefinder field move together so that only one image is visible. The lens is now accurately set for the correct camera-to-subject distance.

Take the Picture



Look through the eyepiece so you can see all of the luminous finder frame. Press the exposure release.

Swing the rapid wind lever all the way out to advance the film and cock the shutter for the next picture.

Unload

When you have taken 20 or 36 exposures and the film counter is at 1, the film advance mechanism locks (see page 13).



Depress the clutch button next to the rapid wind lever.

Pull the rewind knob straight out about a quarter inch and then turn it in the direction of the arrow until the clutch button ceases to rotate.

Open the back of the camera, pull the rewind knob all the way out, and remove the magazine.



detailed instructions begin here

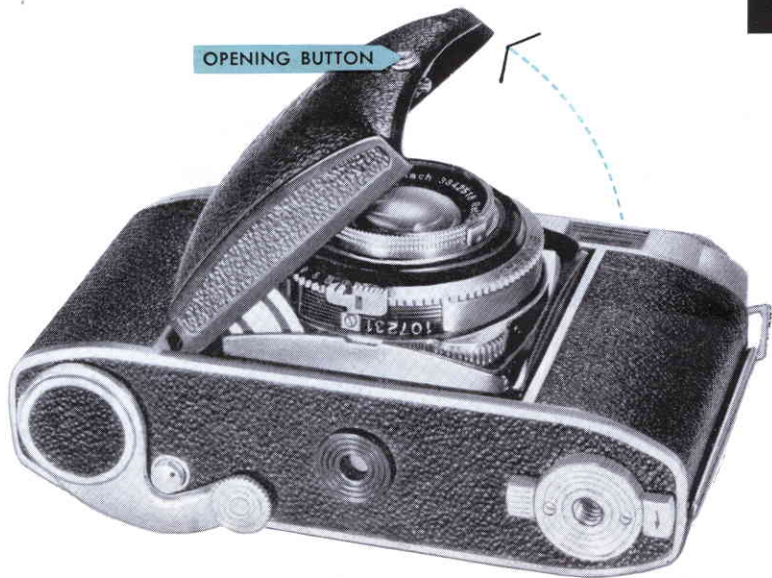

opening

Hold the camera in your hand and press the OPENING BUTTON toward the word "Kodak"; at the same time pull open the protective cover carefully until the shutter panel locks in position.

closing

Move the FOCUSING KNOB down as far as it will go to set the focusing scale to "inf." The closing buttons cannot be depressed until this is done. Simultaneously press the two CLOSING BUTTONS on each side of the shutter panel; then close the cover.

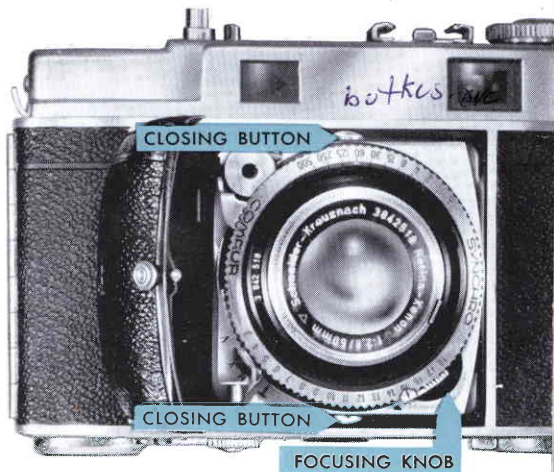

Films

The Kodak Retina IIC Camera uses Kodak 135 Film

COLOR FILMS

Kodachrome Film — For full-color transparencies which can be projected on a screen or from which prints or enlargements can be made.

Use Kodachrome Film Daylight Type for daylight pictures, and Kodachrome Type A for flash or flood-lighted pictures. 20 or 36 exposures.

Kodak Ektachrome Film—Like Kodachrome, Ektachrome Film produces life-like color transparencies for projection or from which color prints and enlargements can be made. The speed of this film, however, is faster than that of Kodachrome Film. You can process this film yourself or see your dealer for processing.

Use Kodak Ektachrome Film Daylight Type for exposure in daylight, and Kodak Ektachrome Film Type F for pictures with clear flash lamps. 20 exposures.

BLACK-AND-WHITE FILMS

Kodak Plus-X Panchromatic Film—An excellent film for general outdoor and well-lighted interior use. The low graininess and high resolving power permit high-quality enlargements. 20 or 36 exposures.

Kodak Tri-X Film—An extremely fast panchromatic film of moderate contrast, low graininess, wide exposure and development latitude, and color sensitivity suitable for all types of indoor and outdoor illumination. 20 or 36 exposures.

If you use an exposure meter, this table should prove useful.

KODAK FILMS

EXPOSURE INDEX

	Daylight	Tungsten
Kodachrome (Daylight)	10	5*
Kodachrome (Type A)	10**	16
Ektachrome (Daylight)	32	12*
Ektachrome (Type F)	20††	16†
Plus-X	50	40
Tri-X	200	160

*With filter such as Kodak Filter No. 80B

**With filter such as Kodak Daylight Filter for Type A Color Films

†With photographic flood lamps and filter such as Kodak Filter No. 82A

††With filter such as Kodak Filter No. 85C

Loading

always load in subdued light

- 1 To open the back of the camera, press the **MILLED LEVER** clockwise; the opposite end of the lever then uncovers the opening **BUTTON**. Press this button and the back springs open.
- 2 Pull the **REWIND KNOB** all the way out.
- 3 Turn the built-in **TAKE-UP SPOOL** by its flange until a slot points upward.
- 4 With the lower edge of the film against the lower take-up spool flange, push the end of the film far enough into the slot to anchor it.
- 5 Pull the film over the film track and insert the magazine in the **SUPPLY CHAMBER**. Then turn the take-up spool by its flange until the **SPROCKET TEETH** engage the film perforations *on both sides*.

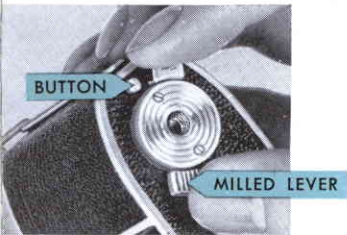

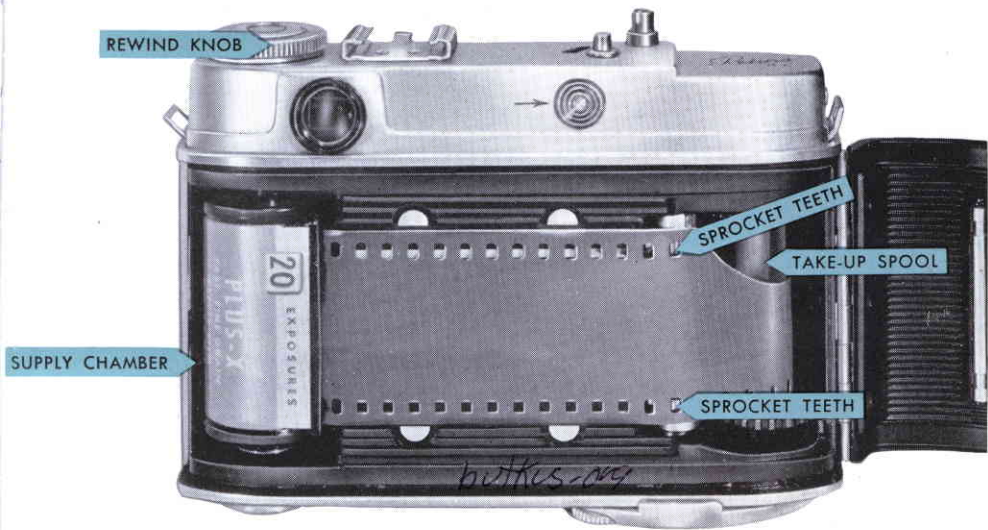

- 6 When the film and magazine are correctly positioned, push in the rewind knob, turning it slightly if necessary. Make sure that the sprocket teeth engage the film perforations *on both sides*.
- 7 Close the back of the camera, by pressing the back against the body until it locks.

Setting the Film Counter

Press and hold down the FILM RELEASE button; then, at the same time, press the film COUNTER ADVANCE in the direction of the arrow as many times as necessary to bring the diamond-shaped mark near 36 on the FILM COUNTER opposite the notch. If you are using a 20-exposure magazine, set to the diamond-shaped mark between 20 and 25. Let go the film release button. Swing out the rapid wind lever as far as it will go; then let it spring back. Do this 2 more times to bring the film counter to 36 or 20, depending on the number of exposures in your magazine.

The film counter always indicates the number of exposures still available. After making an exposure with the counter at 1, a transport lock comes into operation; neither the rapid wind lever nor the exposure release will then operate.

13



Setting the Film Indicator

Set the type of film loaded in the camera on the FILM INDICATOR. Grip the rewind knob with two fingers and turn the inner ring with the thumb of the other hand until the triangular index points to the type of film loaded in the camera.

14



Unloading • always unload in subdued light

To rewind the exposed film, depress the CLUTCH BUTTON in the base of the camera and pull the rewind knob straight out until you feel resistance (about a quarter inch). Then turn the rewind knob in the direction of the arrow until the clutch button ceases to rotate; this is easily observed by the small black dot near the rim of the button. The film is now rewound into the magazine; open the camera back, pull out the rewind knob all the way, and remove the magazine.



15

CLUTCH BUTTON



Sighting the Camera



CLOSE-UPS: Dotted lines show what will appear in final picture relative to what is seen in finder.

Grip the camera with both hands and look through the eyepiece. To sight the pictures properly, hold the camera at that distance from the eye which allows you to frame the subject within the luminous view-frame. When the camera is held either horizontally or vertically, note the two pointers, one on each side near the top of the view-frame. With close-up subjects from $2\frac{1}{2}$ to 6 feet, the subject must be seen within imaginary lines, drawn between each set of pointers, and the opposite sides of the view-frame.

The illustrations at the right, showing the positions for horizontal and vertical pictures, are intended as a guide for holding the camera steady; other positions, of course, are possible. Try a few positions to see which is best.

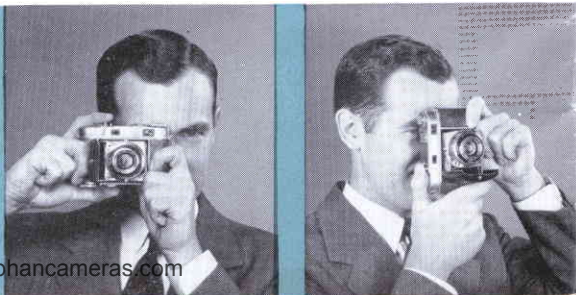

Focusing



Hold the camera in the picture-taking position and look through the eyepiece. You will see the subject outlined by the luminous view-frame. In the center of the field of view you will also notice a diamond-shaped rangefinder field. Until the camera is focused for the correct distance, this field shows a double image of the subject. To set the distance correctly turn the focusing knob until the outlines of the double image move together and coincide, so that only one image is visible. The lens is now accurately set for the film plane*-to-subject distance. Practice focusing in this way with various subjects at different distances—close the camera now and then, and pretend that you have just noticed a good subject and want to focus the camera on it. Open the camera and focus quickly. Practice with the camera held in both the vertical and horizontal positions.

*The film plane location corresponds to the rear top edge of the camera.

Determining Exposure

In addition to the shutter speed and lens opening scales, your camera shutter also has a light value scale. The proper light value to be used is determined by means of the light value table on page 21 or from a light value reading exposure meter.

On the shutter SPEED RING you will find a scale of light values from 3 to 18. Now transfer the light

18

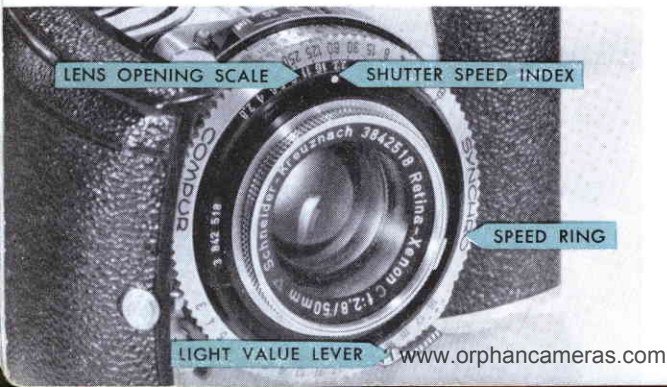

value, determined from an exposure meter or the light value table, to the shutter speed ring. To do this, press down the LIGHT VALUE LEVER slightly and move the pointer to the appropriate number on the scale of the ring. If you cannot move the lever to the desired number, because the lever reaches the limit of its travel, turn the shutter speed ring until the appropriate light value is available. You can set in-between values on the light value scale if you wish an intermediate reading but *not* intermediate shutter speeds.

The SHUTTER SPEED INDEX shows both the exposure time of the shutter and the lens opening. For example: with a light value of 12 the camera may be set for a combination of lens opening $f/8$ and $1/60$ second. Suppose this combination is not suitable for your subject because you need a faster shutter speed such as $1/500$ second for a sports shot. In that case turn the speed ring from $1/60$ to $1/500$ second. This automatically adjusts the lens opening to $f/2.8$ and thus compensates for the

faster shutter speed.

On the other hand, if you intend to take a picture which calls for good depth of field, for example, needing a lens opening such as $f/16$, you must rotate the speed ring to 16 on the LENS OPENING SCALE. This changes the shutter speed to 1/15 second. Such an exposure should, however, only be made from a firm support, for there is risk of camera movement at exposure times of 1/30 second or longer.

If you want to set the exposure without reference to the light value numbers, *be sure to set the shutter speed first* and the lens opening afterwards. If you proceed in the reverse order, setting the shutter speed will also change the lens opening, due to the linkage between the lens opening and the shutter speed setting.

**Exposure Recommendations
based on Light Value
Numbers.**

Average Subjects: Near-by people, gardens, houses, scenes not in shade. Light and dark subjects in about equal proportions. Use this class if in doubt.

	BRIGHT SUN Clear Sky Strong Shadows	HAZY SUN Hazy Sky Indistinct Shadows	CLOUDY BRIGHT No Sun No Shadows	CLOUDY DULL No Sun Dark Sky
COLOR FILMS Kodachrome Daylight, or Type A with Kodak Daylight Filter for Type A Color Films (Shutter speed 1/60 second)	<i>between 11 & 14 at a 500 ft</i> 11.5	<i>between 8 & 11 at a 15</i> 10.5	<i>between 8 & 11 at a 15</i> 9.5	
Ektachrome Daylight (Shutter speed 1/60 second)	13	12	11	10
BLACK AND WHITE FILMS Plus-X (Shutter speed 1/60 second)	13	12	11	10
Tri-X (Shutter speed 1/125 second)	16	15	14	13

LIGHT SUBJECT COLOR FILM—add 0.5 to light value number.
BLACK-AND-WHITE FILM—add 1 to light value number.

DARK SUBJECT COLOR FILM—deduct 0.5 from light value number.
BLACK-AND-WHITE FILM—deduct 1 from light value number.

Note: Side- or Back-Lighted Subject with Color Film—In bright sunlight, add 0.5 to light value number. For important shadow detail in back-lighted close-ups, add 1.0 to light value number.

**Exposure Recommendations
based on Light Value
Numbers.**

Average Subjects: Near-by people, gardens, houses, scenes not in shade. Light and dark subjects in about equal proportions. Use this class if in doubt.

		BRIGHT SUN Clear Sky Strong Shadows	HAZY SUN Hazy Sky Indistinct Shadows	CLOUDY BRIGHT No Sun No Shadows	CLOUDY DULL No Sun Dark Sky
COLOR FILMS	Kodachrome Daylight, or Type A with Kodak Daylight Filter for Type A Color Films (Shutter speed 1/60 second)	<i>between 11 + at a sock</i> 11.5	<i>between 8 + 11 at a</i> 10.5	<i>between 8 + 5.6 at</i> 9.5	
	Ektachrome Daylight (Shutter speed 1/60 second)	13	12	11	10
BLACK AND WHITE FILMS	Plus-X (Shutter speed 1/60 second)	13	12	11	10
	Tri-X (Shutter speed 1/125 second)	16	15	14	13

LIGHT SUBJECT COLOR FILM—add 0.5 to light value number.
BLACK-AND-WHITE FILM—add 1 to light value number.

DARK SUBJECT COLOR FILM—deduct 0.5 from light value number.
BLACK-AND-WHITE FILM—deduct 1 from light value number.

Note: Side- or Back-Lighted Subject with Color Film—In bright sunlight, add 0.5 to light value number. For important shadow detail in back-lighted close-ups, add 1.0 to light value number.

Setting and Releasing Shutter .

Look through the finder eyepiece, sight the subject, and press the EXPOSURE RELEASE. If the shutter is not set you cannot press the button.

To set the shutter, with the right thumb swing out the RAPID WIND LEVER in one movement *as far as it will go*; then let it return to its original position. If it does not return, you did not swing it out far enough. Winding this lever, at the same

EXPOSURE RELEASE



CAUTION: Make sure that you press the button pointed out in the illustration.

time cocks the shutter and—if you have film in the camera—advances the film by one frame and advances the film counter (page 12). Now you can press the exposure release. You will notice how smoothly the release operates; this is important to avoid camera movement.

If during this operation, the rapid wind lever becomes locked, this means either that the exposure release has not been pressed, or that the film counter is at “1” and must be reset to the nearest diamond-shaped mark as described on page 12.

23



RAPID WIND LEVER

Setting the Focusing Scale

In addition to using the coupled rangefinder to determine distance automatically, you can also set the FOCUSING SCALE (for 50mm lens) manually.

The small red dot next to the FOCUSING INDEX is to be used instead of the focusing index when focusing with Infrared Film. Therefore, turn the focusing knob until the figure corresponding to the film plane-to-subject distance is opposite the red dot when using Infrared Film.

The bottom of the focusing ring carries three other scales. These are for use with the interchangeable lenses which are described on page 34.

Depth of Field

After you have properly focused on your subject, the subject will be sharp in the picture. However, other objects in the picture area, both in front of and behind the subject, will also be in focus. This is "range of sharpness" or "depth of field."

To permit instant reading of the depth of field for any lens opening and distance, there is a DEPTH-OF-FIELD SCALE. This scale is composed of the focusing scale and a scale of numbers corresponding to lens openings arranged on either side of the focusing index.

Suppose you have set the aperture to f/8 and the distance to about 9 feet; this is how you read off the depth of field: To the left of the focusing index the line marked with the figure 8 (corresponding to the lens opening)

is opposite 6 feet. To the right of the index another line marked with the figure 8 points to about 16 feet. This tells you that with a setting of about 9 feet at f/8 you have a depth-of-field zone extending from about 6 to 16 feet. Within this zone everything will be sharp.

25



Zone Focusing

Technically good exposures depend largely on the skilled combination of correct distance, shutter speed, and lens opening settings. However, you may encounter subjects where you just haven't the time to work out the ideal setting or to use the rangefinder, if you don't want to miss the picture. For such occasions your camera carries two zone focus settings: one for near and one for distant subjects. With these settings you must, however, have adequate light to give you an $f/8$ setting of at least $f/8$.

For near subjects set the distance to the small circle near the 10-foot mark, and the lens opening to $f/8$. This gives you a depth of field from about $6\frac{1}{2}$ to 20 feet.

For more distant subjects use the small circle near the 15-foot mark and an aperture of $f/8$. This gives a depth of field from about $9\frac{1}{2}$ feet to inf.

*Inside flash - shutter speed 30 - guide # 50
divide distance into 50 which equals lens opening
set green indicator at M - if use flash on ceiling -
increase lens opening by 2 stops*

Flash Pictures

• Flash pictures, in black-and-white or color, are easy to make with your camera. The built-in synchronization of your Synchro-Compur shutter permits the use of flash, including electronic flash, at shutter speeds indicated in the table on page 33. Flash lamps are fired when the camera shutter is released.

Either of two Kodak flashholders can be used with your Retina IIc Camera:

1. The Kodalite Super-M Flashholder with Kodalite Retina Flashholder Bracket (for Kodak Retina IIc, IIc, Ib, and Retinette $f/3.5$ Cameras).* This compact unit uses the low-

*Not recommended for use with the wide-angle Kodak Retina Curtar Lens Component.

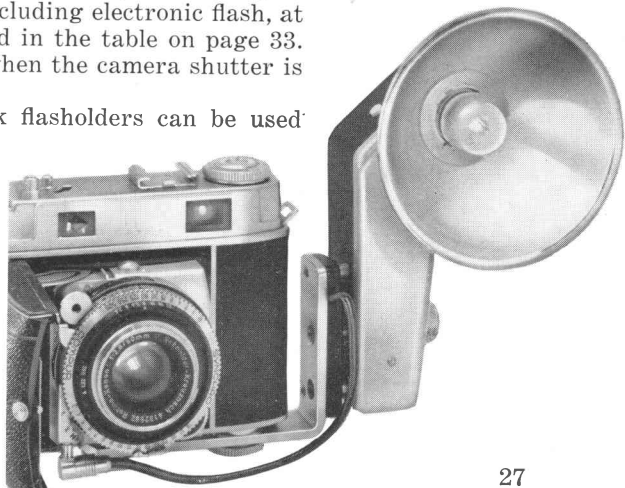

priced, midget-type M-2 lamps. However, bayonet-base No. 5, No. 25 or No. 8 lamps can be used by removing the socket adapter. Full instructions are packed with the flashholder.

2. The Kodak Standard Flashholder with Retina Flashholder Bracket (for Kodak Retina IIIc, IIc, Ib, and Retinette *f*/3.5 Cameras). This larger unit

uses the standard bayonet base lamps and is especially recommended for use with the wide-angle Kodak Retina Curtar Lens Component.



Instructions for use of this flashholder follow.

Attaching the Standard Flashholder

Position the flashholder bracket against the bottom of the camera so that the unthreaded locating pin of the bracket engages the hole in the center of the bottom of the camera, and the thumbscrew next to it engages the threads of the camera tripod socket; tighten the thumbscrew. With the flashholder reflector facing in the same direction as the camera lens, tighten the thumbscrew at the end of the bracket into the threaded receptacle in the base of the flashholder battery case. The threaded hole in the base of the thumbscrew that engages the camera tripod socket provides for attaching the camera and flashholder to a tripod.

A Kodak Single-Post Flashholder Adapter is attached to the bayonet-connector end of the flashholder cord for use with your Retina IIc Camera. Slip the open end of the adapter over the FLASH-POST of the camera. When the flashholder is removed from the camera, the adapter should remain with the flashholder cord.

Installing the Batteries

Batteries are not supplied with the unit but they can be purchased from your Kodak dealer. Get two size "C" batteries (photoflash are best). For extra-strong, long-lasting power, the Kodak B-C Flashpack and one 22½-volt battery are available to power the unit instead of the "C" size batteries.

To install the batteries, loosen the coin-slotted screw on the back of the flashholder, and remove the back. Next, insert the two size "C" batteries between the upper and lower spring contacts of the flashholder with the center contact tips of the batteries up; then replace the back.



IMPORTANT: Successful synchronization requires batteries that will test at least 5 amperes. Batteries that have been stored for long periods, especially under conditions that allow them to dry out, will not be satisfactory. With the B-C Flashpack, current is drawn from a condenser rather than directly from the battery.

Installing the Batteries

Batteries are not supplied with the unit but they can be purchased from your Kodak dealer. Get two size "C" batteries (photoflash are best). For extra-strong, long-lasting power, the Kodak B-C Flashpack and one 22½-volt battery are available to power the unit instead of the "C" size batteries.

To install the batteries, loosen the coin-slotted screw on the back of the flashholder, and remove the back. Next, insert the two size "C" batteries between the upper and lower spring contacts of the flashholder with the center contact tips of the batteries up; then replace the back.



IMPORTANT: Successful synchronization requires batteries that will test at least 5 amperes. Batteries that have been stored for long periods, especially under conditions that allow them to dry out, will not be satisfactory. With the B-C Flashpack, current is drawn from a condenser rather than directly from the battery.

Synchronization • Speed Settings

There are three letters engraved on the block of the flashpost; M and X are synchronizer settings for flash, V is the self-timer setting. (See page 33.) These settings are adjusted by the SELECTOR lever.

Using Class F Lamps, such as SM or SF — Set the synchronizer selector pointer on X (pointer in illustration is set at M), set the shutter speed at any speed from 1 to 1/125 second, and consult the table on page 33 for exposure information.

Using Class M Lamps, such as No. 5, No. 25, or No. 8 — Set the synchronizer selector pointer on M for shutter speeds from 1 to 1/500. See the table on page 33 for exposure information.

Using Electronic Flash — Set the synchronizer selector pointer on X. With electronic flash equipment having no lag in the trip circuit, set the shutter at any speed from 1 second to 1/500 second.

NOTE: Do not use units flashed by means of heavy-duty relays or solenoids. Such units may completely destroy the shutter contacts.

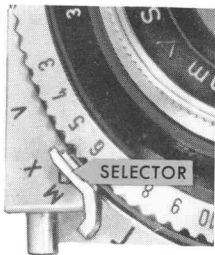

Inserting Lamps

To insert the lamp, place the two pins on the base of the lamp in the slots in the socket; then push the lamp straight into the socket. *Do not twist the lamp.*

To release the lamp from the socket, push the LAMP RELEASE spring located on the top of the flashholder. The lamp will fall from the socket.

Flash lamps are too hot to handle immediately after they have been fired, therefore, never try to pull a lamp out of the socket—use the lamp release. Also, pulling lamps from the socket by force may damage the socket.

Do not insert a flash lamp in the socket if the end of the cord is plugged into the extension terminal on the front of the flashholder handle. The lamp will flash and a serious burn may result.



32

CAUTION: Do not flash lamps in an explosive atmosphere. Since lamps may shatter when flashed, the use of a Kodak Flashguard or similar protective shield over the reflector is recommended.

Flash Exposure Guide Numbers for Kodak Retina IIC with Kodak Standard Flashholder

Flash Guide

To calculate the lens opening, divide the flash exposure guide number by the lamp-to-subject distance in feet.

Cannot use flash with self-timer

THE SELF-TIMER

If you wish to include yourself in a picture, first operate the rapid wind lever; then set the selector pointer to V. Start the self-timer mechanism by pressing the exposure release. The shutter will go off after about 10 seconds; you therefore have sufficient time to take your place in the picture.

If you use the self-timer for flash shots, the shutter works only with the X-synchronization. As the self-timer runs down, the synchronizing lever automatically moves to X. Be sure to use the correct shutter speed setting for X-synchronization, (see table). Class M lamps can also be used at X selector setting for speeds from 1 to 1/30 second.

Lamps	Selector	Shutter Speed	Kodak Film			
			Plus-X	Tri-X	Kodachrome Type A	Ektachrome Type F
SM-SF	"X"	1 to 1/30	85	160	55	
		1/60	80	160	50	
		1/125	75	150	45	
No. 5 or No. 25	"M"	1 to 1/30	150	300	80*	120
		1/60	130	270	70*	100
		1/125	110	220	55*	85
		1/250	85	170	40*	65
		1/500	60	120	30*	45
No. 8	"M"	1 to 1/15	110	220	55*	85
		1/30	95	190	50*	75
		1/60	90	180	45*	70
		1/125	85	170	40*	65
		1/250	70	140	35*	55
			Kodachrome Daylight Type		Ektachrome Daylight Type	
No. 5B or No. 25B	"M"	1 to 1/30	50		80	
		1/60	45		70	
		1/125	35		55	

*With filter such as Kodak Flash Filter No. 81C

Auxiliary Interchangeable Lenses



Attach this finder to the camera by sliding the base shoe of the finder into the clip as shown above. Roll the knurled **FIELD ADJUSTMENT** as far as it will go toward 80 to set the field for the 80mm lens, and toward 35 to show the field for the 35mm lens. The red dot on the adjustment will indicate the finder setting.

Rotate the **PARALLAX DIAL** until a red figure corresponding to the camera-to-subject distance in feet is at the white index dot. Disregard the chrome figures corresponding to the camera-to-subject distance in meters.

Both an 80mm long-focus lens component, especially suited to portraits and long-range subjects, and a 35mm wide-angle lens component, particularly useful when you wish to cover a wide subject field, are available to widen the scope of your Retina IIc Camera. The Kodak Retina 35-80 Optical View Finder (for Kodak Retina IIIc and IIc Cameras), shown at the left, is available to show the field of view for both the 35 and 80mm lenses.

The standard lens of your camera is the 6-element, $f/2.8$, 50mm, Kodak Retina-Xenon C Lens. When the front component of this lens is removed to admit one of the auxiliary lenses, the shutter blades are exposed. Behind the blades is the rear lens component. This forms a complete lens only in combination with the standard,

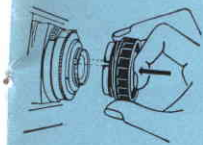

1

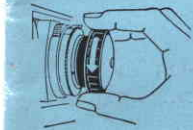

2

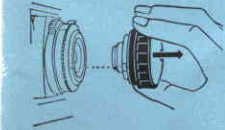

3

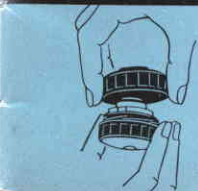

4

telephoto, or wide-angle lens components specified for this camera. *Change lenses in subdued light.*

The front component of the standard lens is locked in place by a bayonet-type, internal snap-lock mechanism. For removal and storage of the front component, the use of the Kodak Retina 50mm Lens Component Case, a special grip-top container, is recommended. As shown in the illustration, after removing the top of the case, (1) press in the transparent center of the top to bring the grip-insert to its full-open position. (2) Place the insert over the lens rim, press the black outer ring toward the lens as far as it will go to tighten the hold of the grip-insert; then turn counter-clockwise. (3) Remove the lens, tilting the camera downward. (4) Without removing the lens from the grip-top, place the bottom of the container over the lens while it is held in the grip-top, engage the threads of the top and bottom of the container, and tighten. The lens can be replaced on the camera by placing the red dot on the lens flange opposite the

red dot on the lens opening ring and turning the lens clockwise until the snaplock engages. *Make sure that the lens is securely seated.*



Telephoto Shots

Telephoto effects can be obtained with the Kodak Retina Longar Lens Component, 80mm $f/4$ (for Kodak Retina Cameras with Xenon C Lenses). To attach the lens to the camera, place the red dot exactly opposite the red dot (arrow in illustration) on the lens opening ring; then press in and turn the lens clockwise until the snap-lock engages.

The rangefinder can be used to focus not only the 50mm lens, but also the 80mm or 35mm lens.

To focus the Longar lens, determine the camera-to-subject distance with the camera rangefinder and note the distance figure opposite the index on the focusing scale for the standard 50mm lens. Now, tilt the camera up and look underneath the shutter to find the TELE-SCALE. Then transfer the measured value to the part of the tele-scale marked

with chrome figures on black. To do this, turn the focusing knob until the measured distance on the tele-scale is opposite the "T" INDEX mark.

By attaching a Kodak Retina 80mm Auxiliary Lens (for Kodak Retina Longar Lens Component, 80mm $f/4$) to your telephoto lens, you can also focus the telephoto lens with the rangefinder for distances from 6 feet to 3.5 feet. In that case, transfer the measured distance to the part of the tele-scale with the gold figures on black.

Make sure that the lens is securely seated.

The rotating ring on the telephoto lens is for indicating depth of field only; the camera cannot be focused with this ring. The distance scale of the ring is engraved in the same colors as the tele-scale as a reminder to set the appropriate scale for correct focus.

37

CAUTION: Remember that the largest lens opening of your Longar lens is $f/4$. Therefore, when moving the speed ring, make sure that the light value lever does not indicate a larger lens opening than $f/4$; that is, $f/2.8$. Otherwise the picture will be underexposed.

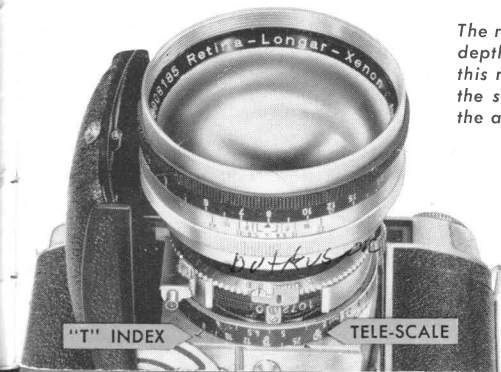

Wide-Angle Shots

CAUTION: Remember that the largest lens opening of your Curtar lens is $f/5.6$. Therefore, when moving the speed ring, make sure that the index does not indicate a larger lens opening than $f/5.6$; that is, $f/4$ or $f/2.8$. Otherwise the picture will be underexposed.

For wide-angle effects with your camera, use the Kodak Retina Curtar Lens Component, 35mm $f/5.6$ (for Kodak Retina Cameras with Xenon C Lenses). To attach the lens to the camera, place the red dot opposite the red dot on the lens opening ring; then press in and turn the lens clockwise until the snap-lock engages.

To focus the Curtar lens correctly, get the camera-to-subject distance with the rangefinder and note the distance figure opposite the index on the focusing scale for the standard lens. Now, transfer the distance figure obtained with the rangefinder to the **WIDE-ANGLE SCALE** (black figures on chrome) by turning the focusing knob to bring the appropriate figure to the triangular **WIDE-ANGLE INDEX**.

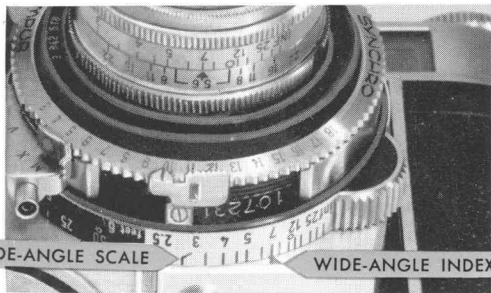

Like the telephoto lens, the wide-angle lens carries a color-keyed scale for indicating depth of field *only*.

Make sure that the lens is securely seated.

Time Exposures

Deep shade in the daytime, interiors, street scenes at night, and many other types of subjects offer opportunities for excellent pictures by time exposures. Exposures vary from one second to several minutes.

To make a time exposure,* place the camera on a tripod; set the shutter at B; set the lens opening; then press the exposure release for the correct interval; the shutter is open while the exposure release is depressed.

*The Kodak Metal Cable Release No. 5 screws into the top of the exposure release.

Multiple Exposures

In normal use of the camera, the interlock system guards against multiple exposure by locking the exposure release after an exposure until the rapid wind lever is actuated; operating this lever also sets the shutter, advances a frame of film, and moves the film counter.

To take an intentional multiple exposure, first make the original exposure; then *press and hold* the CLUTCH BUTTON *while operating* the rapid wind lever. Pressing this button disengages the film advance mechanism but permits the operation of the rapid wind lever to set the shutter. (Use this method also for saving film if flash lamps fail to fire.)

Inasmuch as the film counter is also advanced, one or more frames of film will be available than is shown on the counter. To be able to use these frames of film after the counter reaches 1, press and hold down the film release button; then slide the film counter advance in the direction of the



arrow as many times as is necessary to bring the diamond-shaped mark on the film counter opposite the notch. The rapid wind lever can then be operated.

The Film Release

The FILM RELEASE button can be used to deal with any blockage of the rapid wind lever that may occur. Just press the film release button; if the lever is locked between the start and end of its swing, it will spring back into place.

41



a complete system of photography with the Retina IIC

Certain auxiliary equipment has been referred to and described in the manual. This equipment will extend the picture-taking scope of your Retina Camera.

Filters and Lens Hoods

Your camera accepts the following:

Kodak Filters (Screw-in type, 32mm diameter) for 50mm *f*/2.8 and 35mm *f*/5.6 lenses.

Kodak Filters (Screw-in type, 60mm diameter) for 80mm *f*/4 lens.

Kodak Retina Lens Hood, Bayonet Type, for the 50mm *f*/2.8 lens; and, with the Kodak Retina Lens Hood Extension, for 35mm, *f*/5.6 lens.

Kodak Retina Lens Hood (Slip-on type) for 80mm, *f*/4 lens.

Kodak Retina Field Case Model B (for Kodak Retina IIIc, IIc, and 1b Cameras). Stitchless construction—leather with chrome-finished metal reinforcement—plush lined—pivoting and removable front—adjustable neckstrap. Elastic band inside of top is for storing incident light attachment of exposure meter supplied with the Retina IIIc Camera. To remove front of field case, slide attaching button upward.



**Kodak Retina 50-80 Sports Finder
(for Retina IIIc and IIc Cameras).**

This folding, open-frame finder shows the field covered by the 50 and 80mm lenses. Manual parallax adjustment. 80mm finder frames swing in or out of 50mm frame. Chrome finished. Compact. Supplied in leather case attachable to carrying case strap.

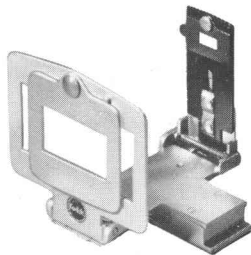

**Kodak Retina Close Range and
Viewfinder Kit, Model B (for Kodak
Retina IIIc, IIc, and Ib Cameras).**

This kit is used for optically measuring film-to-subject distances, and for determining the precise field covered by the 50mm lens supplemented by the N1, N2, or the combination of the N1 and N2 auxiliary lenses. This extends the focusing range of the Retina Camera down to 11 $\frac{5}{8}$ inches film-to-subject distance. Supplied complete: Range and viewfinder with two supplementary lenses in fitted case.

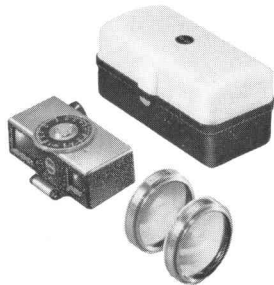

Kodak Retina Close-up Kit, Model B (for Kodak Retina IIIc, IIc, and Ib Cameras). This kit measures close distances (11 to 6 inches) and the field sizes mechanically at 4 settings by means of 4 pairs of field guides. The maximum field covered is about 4 x 6 inches. The minimum is about 1 1/2 x 2 inches. The outfit consists of a field guide holder, 4 pairs of field guides, and 3 R-type auxiliary lenses. For use, the kit requires the Kodak Retina Camera Platform, Model B.

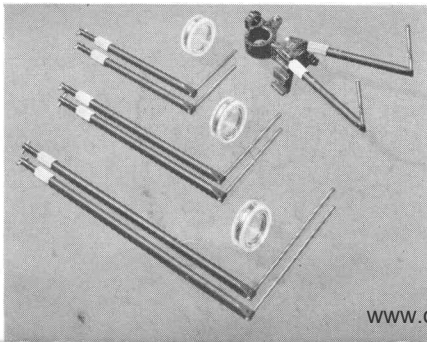

Kodak Retina Camera Platform, Model B (for Kodak Retina IIIc, IIc, Ib, and Retinette f/3.5 Cameras). This platform fits the bottom of the camera and provides a tripod socket in the center of the camera base. It is required for using certain auxiliary items of equipment, such as the Kodak Retina Close-up Kit, Model B. It also can be used with the Kodak Table Top Camera Stand, Model B.

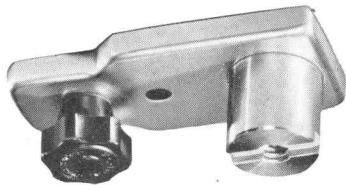

Kodak Table Top Camera Stand, Model B. Consists of base, 2-section telescoping column, ball-and-socket head, and right angle head. It provides flexible yet rigid support for miniature cameras from a few inches to about a foot above the base. Can be disassembled.

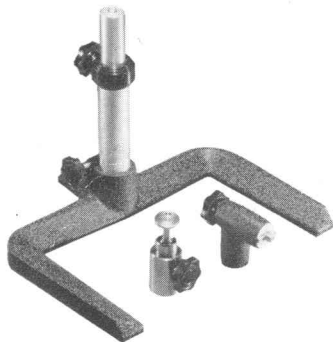

Kodak Retina Microscope Adapter Kit, Model B (for Kodak Retina IIIc, IIc, and Ib Cameras). Photomicrographs can be made easily with the above outfit. Fits practically all microscopes — eyepiece diameter 1 inch. Reduction on the film is 5 to 1. Exposure is made while watching the specimen through the eyepiece. Outfit consists of optics assembly with focusing eyepiece, draw-tube clamping ring, diaphragm lever disengaging ring, and connecting ring.

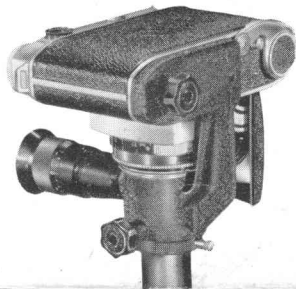

DETAILS

FILM

FILM SIZE—Kodak 135, 20- or 36-exposure magazines

NEGATIVE SIZE—24mm x 36mm

LENS—50mm, f/2.8 Retina-Xenon C, coated, 6 elements

LENS OPENINGS—f/2.8, f/4, f/5.6, f/8, f/11, f/16, f/22

SHUTTER

SYNCHRO - COMPUR — Automatically cocked when film is advanced

SPEEDS—1, 1/2, 1/4, 1/8, 1/15, 1/30, 1/60, 1/125, 1/250, 1/500, and "B"

RELEASE—plunger type on top of camera, or Kodak Metal Cable Release No. 5

SELF-TIMER—Built-in, selector at "V." about 10 seconds delay

FLASH—Built-in synchronization for class F, M, and electronic flash

FOCUSING AND VIEWING

COUPLED RANGEFINDER—Superimposed image type

VIEWFINDER—Optical, projected view-frame type combined with rangefinder

FOCUSING RANGE—2½ feet to infinity

DOUBLE EXPOSURE PREVENTION—Automatic; multiple exposures possible

RAPID WIND LEVER—Advances film and sets shutter with one stroke

CONSTRUCTION

BODY—Die-cast aluminum alloy

TRIPOD SOCKET—In camera base

SERIAL NUMBER—On top of camera, behind accessory clip

Filters and Lens Hoods

Kodak Filters (Screw-in type, 32mm dia.) for 50mm f/2.8 and 35mm f/5.6 lenses

Kodak Filters (Screw-in type, 60mm diameter) for 80mm f/4 lens

Kodak Retina Lens Hood, Bayonet Type, for the 50mm f/2.8 lens; and with the Kodak Retina Lens Hood Extension for 35mm, f/5.6 lens

Kodak Retina Lens Hood (Slip-on type) for 80mm, f/4 lens

EASTMAN KODAK COMPANY • ROCHESTER 4, NEW YORK

DETAILS

FILM

FILM SIZE—Kodak 135, 20- or 36-exposure magazines

NEGATIVE SIZE—24mm x 36mm

LENS—50mm, f/2.8 Retina-Xenon C, coated, 6 elements

LENS OPENINGS—f/2.8, f/4, f/5.6, f/8, f/11, f/16, f/22

SHUTTER

SYNCHRO - COMPUR — Automatically cocked when film is advanced

SPEEDS—1, 1/2, 1/4, 1/8, 1/15, 1/30, 1/60, 1/125, 1/250, 1/500, and "B"

RELEASE—plunger type on top of camera, or Kodak Metal Cable Release No. 5

SELF-TIMER—Built-in, selector at "V," about 10 seconds delay

FLASH—Built-in synchronization for class F, M, and electronic flash

FOCUSING AND VIEWING

COUPLED RANGEFINDER—Superimposed image type

VIEWFINDER—Optical, projected view-frame type combined with rangefinder

FOCUSING RANGE—2½ feet to infinity

DOUBLE EXPOSURE PREVENTION—Automatic; multiple exposures possible

RAPID WIND LEVER—Advances film and sets shutter with one stroke

CONSTRUCTION

BODY—Die-cast aluminum alloy

TRIPOD SOCKET—In camera base

SERIAL NUMBER—On top of camera, behind accessory clip

Filters and Lens Hoods

Kodak Filters (Screw-in type, 32mm dia.) for 50mm f/2.8 and 35mm f/5.6 lenses

Kodak Filters (Screw-in type, 60mm diameter) for 80mm f/4 lens

Kodak Retina Lens Hood, Bayonet Type, for the 50mm f/2.8 lens; and with the Kodak Retina Lens Hood Extension for 35mm, f/5.6 lens

Kodak Retina Lens Hood (Slip-on type) for 80mm, f/4 lens

EASTMAN KODAK COMPANY • ROCHESTER 4, NEW YORK